

# POWERDRIVE<sup>®</sup> PLUS

**1000W**  
POWER INVERTER



OWNER'S GUIDE  
**PWD1000P**

# IMPORTANT SAFETY INSTRUCTIONS

## SAVE THESE INSTRUCTIONS

- This manual contains important safety and operating instructions for the 1000W power inverter. It will help you use your inverter safely and effectively. Please carefully read and follow these instructions and precautions.
- Keep out of reach of children.
- Do not expose inverter to moisture or water.
- The use of an attachment is not recommended or sold by the unit manufacturer, as it may result in a risk of fire, electrical shock, or injury.
- Do not disassemble the unit.
- To reduce risk of electric shock, unplug unit before attempting any maintenance or cleaning. Turning off controls will not reduce this risk.
- For the most effective use, place the power inverter on a flat surface.
- Do not place the inverter on or near heating vents, radiators, other sources of heat, or flammable materials.
- Do not place the inverter in direct sunlight. The ideal air temperature for operation is between 32°F and 104°F.

- The power inverter should only be connected to a 12V battery or power supply. Do not attempt to connect the inverter to any other power source, including an AC power source. Connecting to a 6V or 16V battery will cause damage to the inverter.
- Do not use the inverter with a product that draws a higher wattage than the inverter can power, as this may cause damage to the inverter and product.

## FEATURES

### ❶ ON/OFF Switch

Press and hold for 3 seconds to turn the inverter on and off.

### ❷ 120V Standard AC Outlets (x4)

### ❸ USB-A, USB-C®, with QC 3.0 Tech

### ❹ Removable Remote Control Panel with LCD Screen

### ❺ Positive Battery Cable Terminal (Red)

### ❻ Negative Battery Cable Terminal (Black)

### ❼ Ground Wire

### ❽ High-speed Cooling Fans (x2)

To keep the inverter cool, the fans turn on depending on temperature and load of the inverter. When the inverter is turned off, whether the fans run or not will depend on the temperature of the inverter.

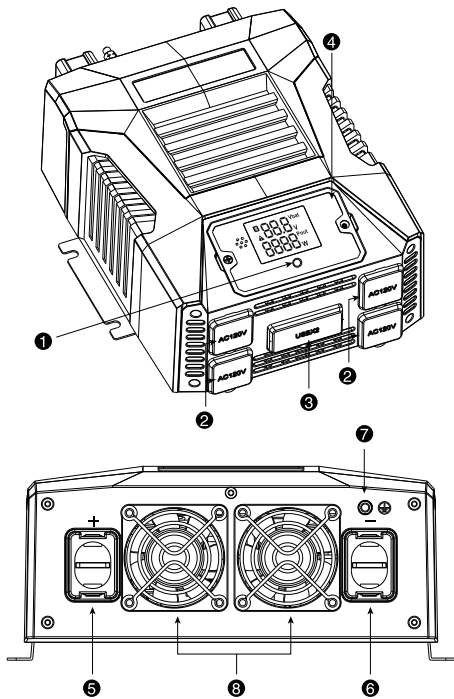

## CONNECTING INVERTER CABLES

### ! IMPORTANT

- The inverter and power source must be in the OFF mode.
- Make sure to only connect your inverter to a 12V power supply. To avoid electrical shock, it is necessary to ground the inverter as well as the power source. The inverter should be grounded, using a 10 AWG copper wire (included).
- Do not turn on the inverter or the power source until the inverter and the power source are grounded.

### TO GROUND THE INVERTER

- ① Turn off and disconnect the inverter.
- ② Locate the chassis ground screw on the back of the inverter.
- ③ Remove the outer nut and loosen the first locking washer.
- ④ Attach the grounding wire's ring connector to the ground terminal of the inverter.
- ⑤ Tighten the locking washer securely. Then, replace the other nut and tighten it securely.
- ⑥ Attach the other end of the wire to a properly grounded location:

**Vehicle:** Connect to the chassis, unpainted frame part, or engine block of the vehicle.

**Fixed location:** Connect to a ground rod or other appropriately rated ground.

## CONNECTING INVERTER CABLES TO THE INVERTER

- ① Locate the Positive and Negative terminals on the inverter.
- ② From the Positive (red) and the Negative (black) terminals, remove the nut, split lock and flat washer.
- ③ Place the Positive (red) ring connector onto the Positive (red) inverter terminal. Place the Negative (black) ring connector onto the Negative (black) inverter terminal.
- ④ Place a flat washer and split lock on top of each ring connector. Put a nut over these and tighten.

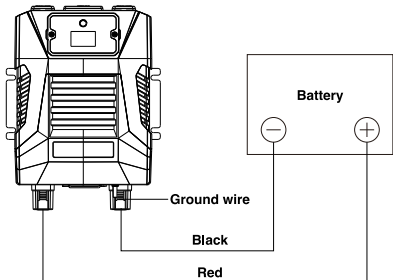

## OPERATING INSTRUCTIONS

- ① Connect the inverter. See Connecting Inverter Cables section.
- ② Press and hold the On/Off button for 3 seconds to turn on the inverter.
- ③ The LCD backlight will turn to blue, and Input Volts and Output Watts will show on the LCD screen, indicating the inverter is receiving power.
- ④ Press and hold the On/Off button for 3 seconds to turn off the inverter. The internal speaker may make a brief “beep” sound. This is normal.
- ⑤ Make sure the device to be operated is turned off.
- ⑥ Plug the device into the inverter’s AC outlet.
- ⑦ Press and hold the On/Off button for 3 seconds to turn off the inverter.
- ⑧ Turn the device on.
- ⑨ To disconnect, reverse the above procedure.

**NOTE:** If more than one device is to be powered, start one device at a time, to avoid a power surge and overloading the inverter. The surge load of each device should not exceed the inverter’s continuous operation wattage rate.

**IMPORTANT:** Using the inverter with some rechargeable devices may damage the inverter and/or device. If you are using the inverter to operate a rechargeable device, monitor the temperature of the inverter for about 10 minutes. If the inverter becomes abnormally hot, disconnect it from the device immediately; do not use the device with the inverter.

## Removable Faceplate Remote Control

- Remove the screws fixing the panel. Do not lose the screws.
- Follow the diagram below to connect the panel and extension cord.

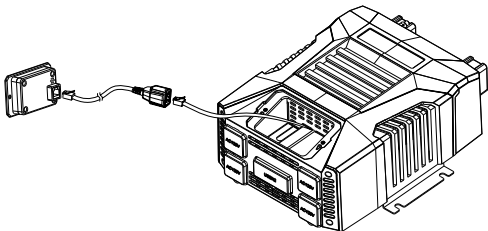



## LCD SCREEN AND FAULT CODE

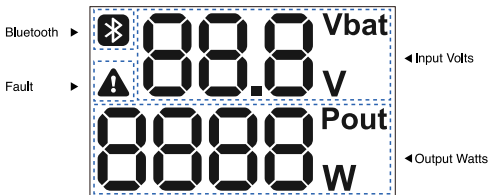

The LCD backlight turns blue automatically when the inverter is plugged into a 12V DC power source and is turned on. Under the following conditions the LCD backlight will turn red, the fault code will be displayed on the screen, the alarm will sound, and the inverter will automatically turn itself off.

### **Lob** Low-Voltage Protection

When the power input from the vehicle's battery drops to approximately 10.5V, the low-voltage alarm will sound. When the voltage goes down below 10 VDC, the inverter shuts off. Recharge or replace the battery.

### **H 16** High-Voltage Protection

When the power input from the vehicle's battery exceeds 16V, high-voltage protection occurs.

## **OL** Overload Protection

The continuous load demand from the equipment or device being operated exceeds the continuous load rating of the inverter. Use a higher capacity inverter or lower rated device.

## **HO** Overheat Protection

The thermal resistor exceeds 80° C (176° F). Allow the inverter to cool. Do not block the cooling slots or air flow over and through the inverter. Reduce the load on the inverter to the continuous rated output.

## **SCP** Short Circuit Protection

When the output is shorted, Short-Circuit Protection is activated.

### **RESET:**

To reset after shutdown occurs, press and hold the On/Off button to turn off the inverter. Check the source of the problem and correct. Then, press and hold the On/Off button to turn on the inverter.

# About the Bluetooth® APP

## THE MAIN FUNCTIONS

- Remote control signal range: best 10m/30ft;
- Real-time display of Input Voltage / Output Voltage / Output Power / Power source level;
- Display working hours, set auto-off time;
- Fault / Protection display;
- Real-time monitor of the temperature, to avoid potential safety hazard;

## HOW TO DOWNLOAD THE APP?

### Android Phone:

Go to Google Play and search "PowerDrive Plus".

### iPhone®:

Go to the App Store® and search "PowerDrive Plus".

*You can also scan the QR code below to download the APP.*



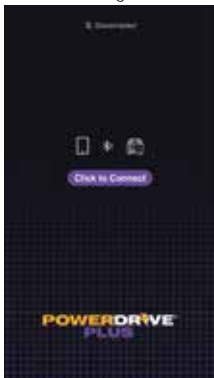

## OPERATION INTRODUCTION

- ① Make sure the inverter is connected to the battery.
  - ② **Inverter Pairing:** Place your phone close to the inverter (within 6.5ft) for first time use. Click [Click to Connect](#) to enter the Bluetooth search list. Find the item number of the inverter you purchased, and click to connect.
- Once the connection is successful, the pairing is considered successful, and the APP will be automatically connected when it is used again. The paired inverter can be connected up to about 20ft in the absence of obstructions.
  - To reinstall the APP, some phone models need to be paired to the inverter again.



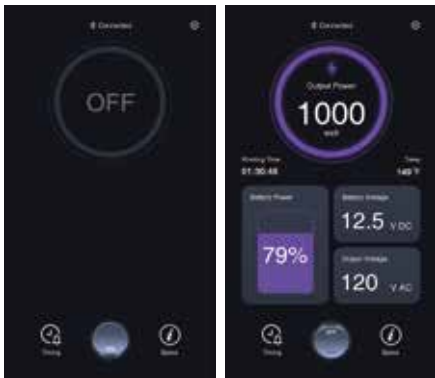



- ③ **ON/OFF:** Click the button at the bottom of the phone screen to control the ON and OFF of the inverter.



- ④ **On & Off Timer:** Click  to set the startup or shutdown time in the pop-up box. It can be set for up to 30 days. After successfully set, a countdown will appear in the middle of the screen, and the Timing icon will change from white to purple. Click again to cancel the timer.

- If you manually click the switch button after the timer is set, it will automatically cancel the set timer.
- Disconnecting the inverter from the battery will cause timer failure.

- ⑤ **Change the name of the inverter:** The default name of the inverter is the item number. You can customize the name in the APP settings. The length of the name is 1-16 characters. Click  to enter the setting interface, click "Change Bluetooth Name" to enter the name, and click to confirm.
- Some phones will disconnect briefly and then automatically reconnect.
- ⑥ **Switch inverters:** When you have more than one inverter, you may need to switch inverters. Click  to enter the setting interface, click Switching Devices to enter the Bluetooth search interface, and click the name of the inverter with which you want to connect. If the inverter you want to connect to has not been paired, it will not appear in the search list. Please move your phone close to the inverter you want to connect to (within 6.5 ft) and click  to refresh the list.
- ⑦ **Device Management:** Click  to delete the paired inverter. When the list is emptied, it will automatically jump to the Bluetooth search interface.
- ⑧ **Inverter Alarm:** The fault alarm buzzer sound can be turned on or off on the inverter.
- ⑨ **Phone Alarm:** The fault alarm buzzer sound can be turned on or off on the APP.
- ⑩ **Reset TEMP Unit:** Switch the temperature unit.

## PROTECTION AND ALARM

This interface will show up when the inverter enters protection mode. The APP will make an alarm sound. The alarm sound can be shut down in Settings. If you are not running the APP, or running it in the background, there will be no alarm sound.

Press and hold the On/Off button for 3 seconds to turn off the inverter.

## POWER SOURCE

- Your average automobile battery at full charge will provide an ample power supply to the inverter when the engine is on.
- Keep the vehicle running at all times when using the inverter.
- The actual length of time the inverter will function depends on the age and condition of the battery and the power demand being placed by the device being operated with the inverter.
- When possible, recharge your batteries when they are not at less than 50% battery life. This gives the batteries a much longer life cycle than recharging when they are almost dead.

### IMPORTANT:

The inverter draws low amperage from the battery when the inverter is turned on but no load is connected. To prevent battery discharge, turn the inverter off when not in use.

## IF THE INVERTER'S FUSE BLOWS

- The fuse should not have to be replaced under normal operating conditions. A blown fuse is usually caused by reverse polarity or a short circuit within the device or equipment being operated.
- If a fuse does blow, take the inverter to a qualified technician for repair.

**NOTE:** do not attempt to service the inverter yourself. Dangerous electrical conditions exist even when the inverter is not connected to a battery.

## MAINTENANCE AND STORAGE INSTRUCTIONS

- Before each use, ensure that all of the inverter's components are in place and in good working condition.
- After use and before performing maintenance, unplug and disconnect the inverter.
- Use a clean, dry cloth to wipe external surfaces of the inverter's case.
- Servicing does not require opening the unit, as there are no user-serviceable parts. All servicing should be performed by qualified service personnel.
- Store inside, in a cool, dry place, out of the reach of children.
- Recycle or properly dispose of internal electrical components.



## TROUBLESHOOTING

<b>PROBLEM</b>	<b>POSSIBLE CAUSE</b>	<b>SOLUTION</b>
Low or no output voltage.	Poor contact at terminals. Using incorrect type of voltmeter to test output voltage.	Disconnect and reconnect the 12V connections. Use a true RMS reading meter.
The LCD backlight is red.	Check the Fault Code on the LCD screen.	Recharge or replace the battery. Use a higher capacity inverter or decrease the load or device on the inverter. Allow inverter to cool. Check for adequate ventilation. Reduce the load on the inverter to the rated continuous power output.
Device does not operate properly when first connected to the inverter.	The inverter may not have the required capacity to operate the device.	Press and hold the ON/OFF button to turn off and on, this will reset the inverter.

## SPECIFICATIONS

Model	PWD1000P
Input	10-15V DC
Output at 13V	120V AC $\pm$ 10%
Output Frequency	60 $\pm$ 3 HZ
Output Waveform	Modified Sine Wave (MSW)
Continuous Power	1000W
Surge Power	2000W
Efficiency Typical at 13V	84% Max
No Load Draw Typical at 13V	0.8A
Low Battery Shutdown	10.5 $\pm$ 0.5V DC
USB-A Output Port	5V 3A, 9V 2A, 12V 1.5A
USB-C® PD Fast Charging Port	0.5 - 15W, 5V, 0.1 - 3.0A 15 - 27W, 9V, 1.67 - 3.0A 27 - 45W, 15V, 1.8 - 3.0A 45 - 100W, 20V, 2.25 - 3.0A
AC Output Socket	4 Standard North American socket
Internal Fuse/ Replacement Fuse	3*40A
Operating Temperature	32°F - 104°F
Battery Low Alarm	10.5 $\pm$ 0.5V DC
Power Cable Length	4 AWG 39.3"
Output Power Overload Shutdown Level	1300 $\pm$ 300
Dimensions	10.70"×8.08"×4.25"
Net Weight	2.49 lbs.

The PowerDrive stylized design and RoadPro are registered trademarks owned by DAS Companies, Inc. and/or its affiliates. PowerDrive is a trademark owned by DAS Companies, Inc. and/or its affiliates. The BLUETOOTH® word mark and logos are registered trademarks owned by Bluetooth SIG, Inc. and any use of such marks by DAS Companies, Inc. is under license. All other trademarks registered trademarks, copyrights and logos are the property of their respective owners. ©2021 DAS Companies, Inc. and/or affiliates.